



RENEWABLE ENERGY TECHNOLOGIES

MAKING THE SOLAR PANEL STAND AND INSTALLING THE PANELS

MODULE

2022-2-TR01-KA210-VET-000098216

IN RENEWABLE ENERGY TECHNOLOGIES NEW APPLICATIONS ACCORDING TO 4.0 STANDARDS



Co-funded by the
European Union

"The European Commission's support for the production of this publication does not constitute an endorsement of the contents, which reflect the views only of the authors, and the Commission cannot be held responsible for any use which may be made of the information contained therein."



This learning material was prepared within the scope of the New Applications in Renewable Energy Technologies According to 4.0 Standards project numbered 2022-2-TR01-KA210-VET-000098216. It is intended to guide vocational education trainers. It is free for users, cannot be sold or reproduced. It will be published as an e-book on the Project Website (<http://www.renewableenergy40.com>).

DESCRIPTIONS

FIELD	Renewable Energy Technologies
OCCUPATION	Solar Energy Systems
NAME OF THE MODULE	Making the Solar Panel Stand and Mounting the Panels
DESCRIPTION OF THE MODULE	<p>This module is a learning material that provides information about making a solar panel stand and installing solar panels on the stand..</p>
SUFFICIENCY	Recognizes the parts of the solar panel stand and assembles the parts of the solar stand and installs the solar panels on the stand.
PURPOSE OF THE MODULE	<p>General purpose You will be able to turn it into a carrier system by manufacturing the metal components specified in the project. You will be able to make panel cable transitions by placing the panels according to the sequence determined in the project.</p> <p>Purposes</p> <ol style="list-style-type: none"> 1. Will be able to manufacture metal components according to the dimensions specified in the project. 2. It will be able to enable metal parts to become a carrier system. 3. Will be able to mount solar panels on stands using appropriate equipment. 1. 4. Will be able to make cable transitions of panels using appropriate tools..

1. SOLAR STAND INSTALLATION

1.1. Sun Stand Direction Adjustment

In order to maximize the energy production from the solar panel, systems are needed so that the solar panel stand sees the sunlight at the right angle from sunrise to sunset. These solar energy systems maximize the production of electricity from solar energy by holding the solar panel at the right angle in many different ways.

Before installing the solar stand, the direction should be checked and the system should be mounted facing south (Picture 1.1). In addition, care should be taken to ensure that the area where the solar stand will be installed is located in an area that will not be shaded by other solar stands, trees and buildings. Before starting to install the system stand, direction and shadow calculations should be made with the help of a compass. In order for solar panels to work properly, they must face south..



Picture 1.1: Solar panel stand

1.2. Sun Stand Assembly

Operational safety must be ensured when assembling the solar stand. Employees must tie themselves to the solar panel pole with the help of a seat belt. Gloves should be used when carrying the products to the installation location and the stand should be protected from wind etc. It should not be placed in areas that will cause it to fall down due to impacts, and if necessary, it should be attached to a fixed part. During transportation and installation of the solar stand, people should be prevented from being in front of or passing by the installed location. Solar stand installation directly affects the efficiency of solar energy. The solar panel stand is connected to the previously prepared solar stand pole with the help of connection apparatus. (Resim 1.2).



Picture 1.2: Solar stand installation



To play the video, click on the image or click the link below and open it with your browser.

https://www.youtube.com/watch?v=c_-Ub3uK-U

1.3. Sun Stand Angle Adjustment

When assembling the sun stand, it should be adjusted to receive sunlight at high degrees such as 90° (Figure 1.3). In line with this information: If the system to be installed is planned to be used both in summer and winter, the inclination angle of the solar stand should be the same as the latitude angle of that region. If the system is planned to be used only in summer, the latitude angle of the solar stand should be 15° lower than the latitude of the region (since the sun's rays come vertically in summer). If the system is planned to be used only in winter, the latitude angle

of the solar stand should be 15° higher than the latitude of the region (since the sun's rays come horizontally in winter).

Türkiye is located between $36^\circ - 42^\circ$ Northern latitudes and $26^\circ - 45^\circ$ Eastern longitudes. When adjusting the angle of the sun stand, the installation should be made taking into account the northern latitudes of our country ($36^\circ - 42^\circ$ northern latitudes). It is necessary to position the solar panel stand so that it faces the sunlight at noon during the summer and winter seasons. Otherwise, the efficiency of the solar panel will be low.

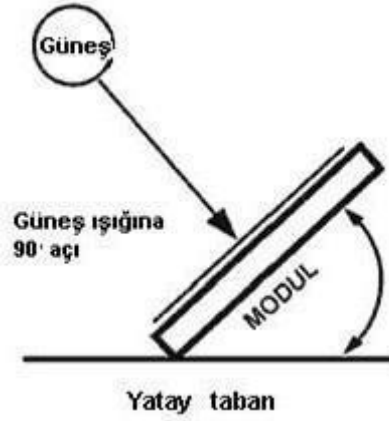

Picture 1.3: Solar panel stand

In snowy areas, it is necessary to clean the solar panels from snow and to clean the solar panel surface and adjust the angle of the solar stand at least every 4 months. Sunlight is approximately 15 hours per day in summer and approximately 9 hours per day in winter. The solar stand provides the highest solar energy efficiency with a vertical or closest angle to the sun.

In the latitudes where Turkey is located, only 1/3 of the solar energy obtained in summer is obtained in winter. Frankly; Three times more electrical power can be produced in summer than in winter. For this reason, it would be more accurate to calculate solar panel energy according to winter and summer conditions. When you manually adjust the vertical angle of the solar panels on a 3 or 4 month schedule, you can achieve the appropriate angle throughout the year. In order to get the best efficiency from solar energy, it is necessary to make seasonal vertical angle adjustment and surface cleaning in fixed installations. As a result of the angle adjustments and maintenance to be made according to the seasons, solar energy panels will have at least 10% extra efficiency can be obtained.

2. STRUCTURE AND ARRANGEMENT OF SOLAR PANELS

2.1. Structure and Types of Solar Panels

Solar panels are devices that convert sunlight into electrical energy (Picture 2.1). They work by using the photovoltaic effect of sunlight. Solar panels can be used to generate electricity in homes, workplaces and industrial facilities.

Solar panels (PV modules) consist of photovoltaic (PV) cells. Photovoltaic cells are made of semiconductor materials. When sunlight hits photovoltaic cells, it causes the movement of electrons. This movement causes electric current to occur. These cells are also called solar cells and solar cells.

French physicist Alexandre Edmond Becquerel first discovered the photovoltaic effect in 1839. Later, in 1883, Charles Fritts discovered the first solar cell with an efficiency of 1%, and with the advancement of technology, more efficient and advanced photovoltaic cells have survived to the present day as a result of the work of many scientists.

The most important parameter used to determine the performance of solar panels is efficiency. It is the ratio of the energy coming out of the solar panel to the light energy coming from the sun.

To determine the efficiency of the solar panel, it is necessary to compare the power provided by the sun to the panel with the electrical power received from the panel. If the solar panel converted all the sunlight falling on it into electrical energy, the efficiency would be 100%. Technically, this is not possible with today's technology. The efficiency level that can be achieved in solar panels today is around 33%..



Picture 2.1: Structure of the solar panel

2.2. Photovoltaic Cell Structure

Solar cells are photovoltaic devices that convert light energy into electrical energy. Solar cells work as a semiconductor diode.

The dimensions of these cells, whose thickness is so thin that they can be measured in micrometers, are generally square, rectangular or circular. The energy obtained from a single PV cell is quite low. For this reason, cells are connected in series or parallel to form modules, and modules combine to form panels. To produce large amounts of electricity, panels are connected to each other to form a solar PV array. Solar cell cells contain N-type and P-type semiconductors.

(Figure 1.1). N and P type materials are produced in a controlled manner by combining semiconductor materials with additives in their molten state.

Polycrystalline silicon is mostly used as a semiconductor material in solar cells.

The structure of solar cells is shown schematically (Figure 2.2).. The working principle of the solar cell is as follows:

- ☛ When sunlight falls on the solar cell, it is absorbed by the cells. In the cell, there is a P-type semiconductor material with many electrons and an N-type semiconductor material with few electrons.
- ☛ Sunlight removes electrons from the P-type semiconductor material.
- ☛ Electrons that gain energy flow towards the N-type semiconductor material.
- ☛ This constant unidirectional flow of electrons results in the formation of direct current (DC). Electrons can flow through established circuits and be used or stored where electrical current is required.
- ☛ Photovoltaic solar panels are manufactured by electrically combining these cells..

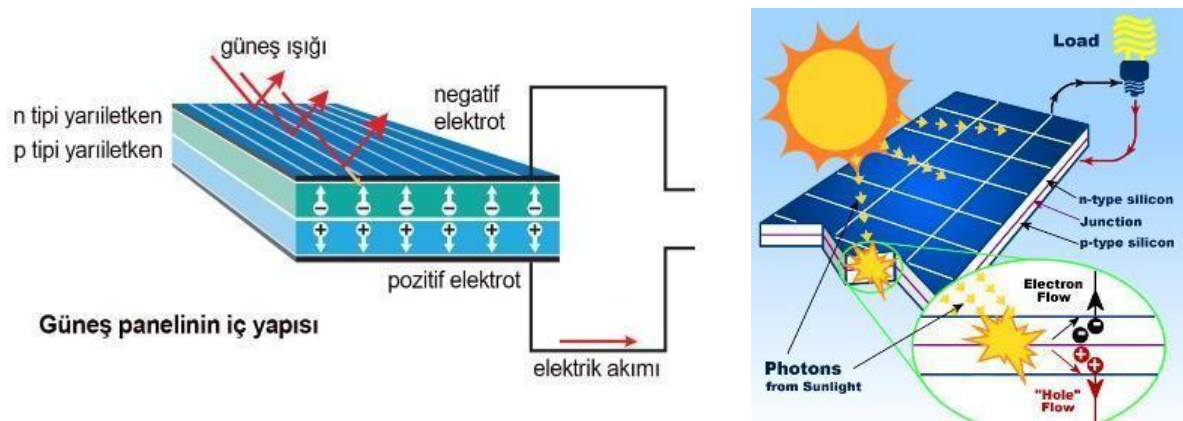

Picture 2.2: Structure and working principle of the solar cell

2.3. Assembling Solar Cells

The voltage of solar cells varies between 0.5V-0.6V depending on the amount of sunlight falling on them. Regardless of the size of the solar cell, the voltage does not change, but the current (amperage) varies depending on the surface area.

Solar cells are usually connected in series within the solar panel. There are 36 solar cells in the panel, which creates a voltage (volt) between 18-21V.

The purpose of connecting solar cells in series is to set the appropriate output voltage. In this case, the current will remain constant.

Relationship between power, current and voltage;

$$P= I*V$$

$$I=P/V$$

$$V=P/I$$

P=power (Watt)

I=Currency (Amper)

V=Voltage (Volt)

In the picture (2.3), there are 4 solar cells connected to each other in series. Assuming that each battery is 2 amps and 0.5 V, the current of the solar panel will be 2 amps and 2 V voltage and the panel will have 4W power..

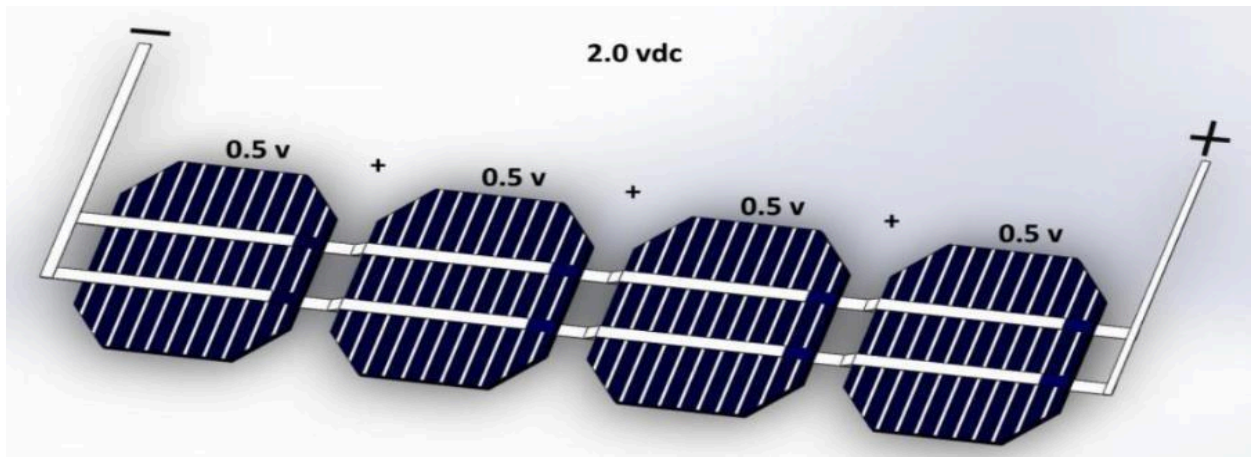

Figure 2.3: Solar cell cells connected in series

Power Current Relationship

As shown in (Figure 2.1), the maximum power of the photovoltaic cell is equal to the product of the current and voltage values at the end point that creates the maximum area under the current voltage curve.

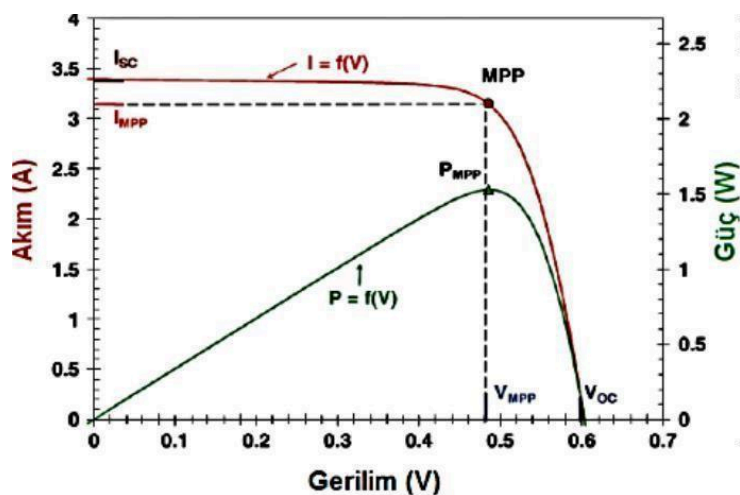

Figure 2.1: Current, voltage and power curve of the photovoltaic cell

Effect of Solar Radiation Intensity

The maximum power of the photovoltaic cell varies depending on the solar radiation intensity. As solar radiation intensity decreases, electricity production decreases as a result of the decrease in the voltage produced by the photovoltaic cell and the decrease in the current drawn from the cell. (Figure 2.2) shows the effect of decreasing solar radiation intensity on the maximum power point.



Figure 2.2: Change of current and voltage depending on solar radiation

Temperature Effect

It is seen that the cell temperature has no effect on the current and suffers a loss of 1.5-2 mV depending on each degree of temperature increase (Figure 2.3).

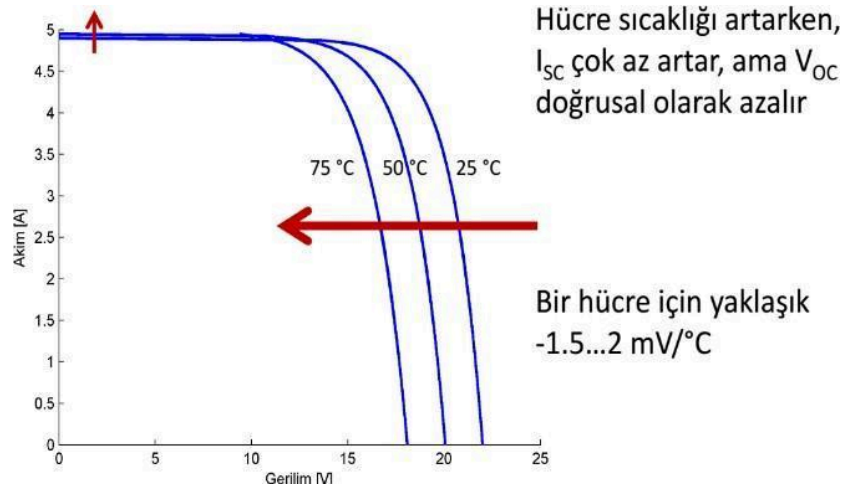

Figure 2.3: Change of current and voltage depending on temperature



To play the video, click on the image or click the link below and open it with your browser.

https://www.youtube.com/watch?v=0aaYLS_pc3I

2.4. Types of Solar Panels

Solar panels can be diversified according to their production technologies as follows:

Monocrystalline solar panels: These are near-black colored solar panels consisting of solar cells made of a single silicon crystal. It is the panel type with the highest efficiency among other panel types, with 15-20% efficiency (Picture 2.4). Their average lifespan is about 25 years. It can be easily distinguished from other panels with its almost black colors and equal surfaces. Dimensions of monocrystalline solar panels vary depending on power and number of cells. It can be in the power range of 10-420 watts and different cell numbers. The fact that they are more difficult and costly to produce, their higher efficiency and longer lifespan are the reasons that make these panels quite expensive. These panels are generally used in spaces with high energy needs and limited surface area.

It is preferred in projects such as stations, satellites, high-tech products, and regions that are relatively cloudier and have less sunlight time..

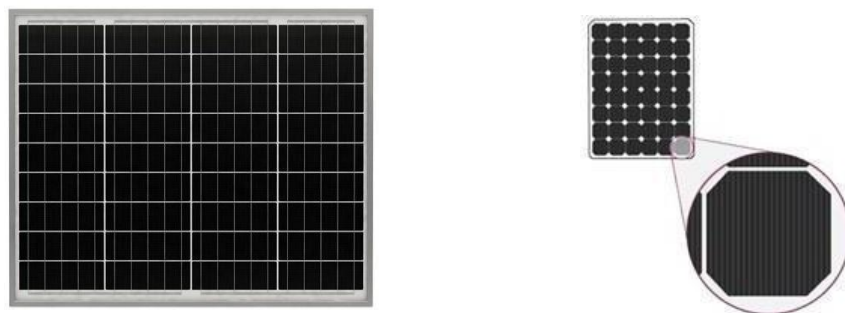

Picture 2.4: Monocrystalline solar panel

Polycrystalline solar panels: It is a near-blue colored solar panel consisting of multiple silicon crystals. Among other panel types, it has a lower efficiency than monocrystalline panels, with an efficiency of 13-16% (Picture 2.5). Their average lifespan is between 20-25 years. It can

be easily distinguished from monocrystalline panels with its blue-like colors and different surfaces. Dimensions of polycrystalline solar panels vary depending on power and number of cells. It can be in the power range of 10-300 watts and different cell numbers. The fact that their production is easier and less expensive, their efficiency is lower, and their lifespan is slightly shorter are the reasons that make these panels more affordable. These panels are generally preferred in homes, small businesses and areas that do not require large energy needs..



Picture 2.5: Polycrystalline solar panel

Thin film (amorphous silicon) solar panels: It is a solar panel with a flexible structure consisting of different materials (for example, amorphous silicon, CIGS, CdTe). It has the lowest efficiency among other panel types, with 10-12% efficiency. Their average lifespan is between 10-15 years. It can be easily distinguished from other panels with its flexible structure and generally gray or brown colours. The dimensions of thin film solar panels vary depending on power and number of cells. It can be in the power range of 5-150 watts and with different cell numbers (Picture 2.6). The fact that their production is easier and less costly, their efficiency is lower and their lifespan is shorter are the reasons that make these panels more affordable. However, due to their low efficiency, they require more space to produce the same energy. These panels are generally preferred in large areas such as roofs with large areas, agricultural areas and commercial buildings..

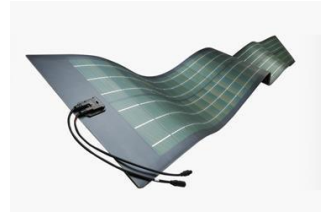

Figure 2.6: Thin film (amorphous silicon) cell and panel

Nano-textured solar panels: Nano photovoltaic technology is the solar cell technology of the future. It includes nano-microcrystalline high efficiency solar cells. NanoPV batteries provide 8-10% more efficiency than other solar cells with the hydrogen amorphous silicon and permeable conductor (TCLO) technology in their structure. The initial investment cost of solar panels produced with this technology is considerably higher than other solar panels. Three types of materials are used in nano photovoltaic technology: Crystalline semiconductor materials, Polymeric materials and Carbon-based nanostructures..

Flexible solar panels: These are solar panels with a flexible and lightweight structure, generally consisting of amorphous silicone, polymer or organic materials (Figure 2.7). Among other panel types

It has a low yield with 7-12% yield. Their average lifespan is between 5-10 years. Thanks to their flexible structure, they can be mounted on complex surfaces and even on clothing. The dimensions of flexible solar panels vary depending on the power and number of cells. It can be in the power range of 1-100 watts and different cell numbers. The fact that they are not easy and costly to produce, have low efficiency, and have a short lifespan make these panels an affordable option. However, due to their low efficiency, they require more space to produce the same energy. These panels are generally preferred in areas that need portable energy, tents, yachts and even wearable technology products..



Picture 2.7: Flexible solar panel

Transparent Solar Panels: These are solar panels that consist of special materials (for example, organic photovoltaic cells, perovskite cells) and have a transparent structure (Picture 2.8). It has the lowest efficiency among other panel types, with 5-10% efficiency. Their average lifespan is between 10-15 years. Thanks to their transparent structure, they can be mounted on glass facades, windows and other transparent surfaces. The dimensions of transparent solar panels vary depending on the power and number of cells. It can be in the power range of 5-100 watts and different cell numbers. The fact that their production is complex and costly, their efficiency is low and their lifespan is short make these panels an expensive option. However, it is ideal for projects that want to combine aesthetics and functionality. These panels are generally preferred in commercial buildings, shopping malls and places where an aesthetic appearance is

desired..



Picture 2.8: Flexible solar panel

Hybrid Solar Panels: Solimpeks PowerVoltHybrid solar panel is a system that produces electrical energy and provides domestic water at the same time (Picture 2.9). While these solar panels produce electrical energy with the cells on the upper surface, they store domestic water with the high-efficiency copper plates on the back of the solar panel. Thanks to the circulation of the cool liquid passing through the solar panel, the heat generated in the cells is removed and the efficiency in electrical energy production is increased. Thus, maximum recycling of solar radiation is achieved..

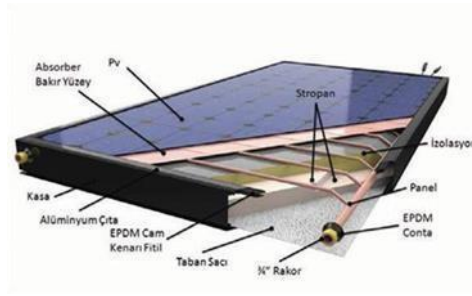

Picture 2.9: Flexible solar panel

2.5 Panel Grouping Calculation

To produce large amounts of electricity, panels are connected to each other to form solar PV arrays (Figure 2.10). Solar energy can be converted into electrical energy with an efficiency between 5% and 20%, depending on the structure of the solar cell..

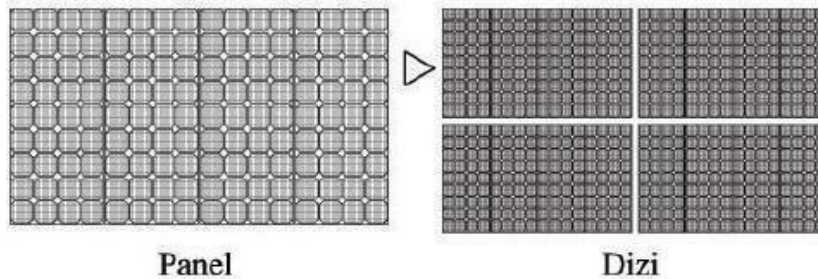

Picture 1.10: Solar array formation from solar panels

In order to increase power output, many solar panels are connected to each other in parallel or series and mounted on a surface. This structure is called solar module or photovoltaic module. Depending on the power demand, modules are connected to each other in series or parallel to create systems ranging from a few Watts to megaWatts.

There are several critical factors to consider when choosing a solar panel connection type. Energy needs, scale of the project and budget directly affect this choice. For example, high

energy

Serial connection may be more suitable for a project that requires it. Additionally, physical factors such as spatial constraints and shading also play a role in determining the type of connection. Finally, the features of the inverter to be used and local regulations are other important factors affecting this decision..

Series Connection Solar Panels

Series connection is a system in which the positive lead of one panel is connected to the negative lead of the next panel. This type of connection keeps the current constant while increasing the total voltage. Serial connection is generally preferred in projects that require high voltage and long-distance energy transmission. However, in this type of connection, failure or shadowing of one panel can negatively affect the entire system. On average, series connections provide higher energy efficiency but also require more attention and maintenance.

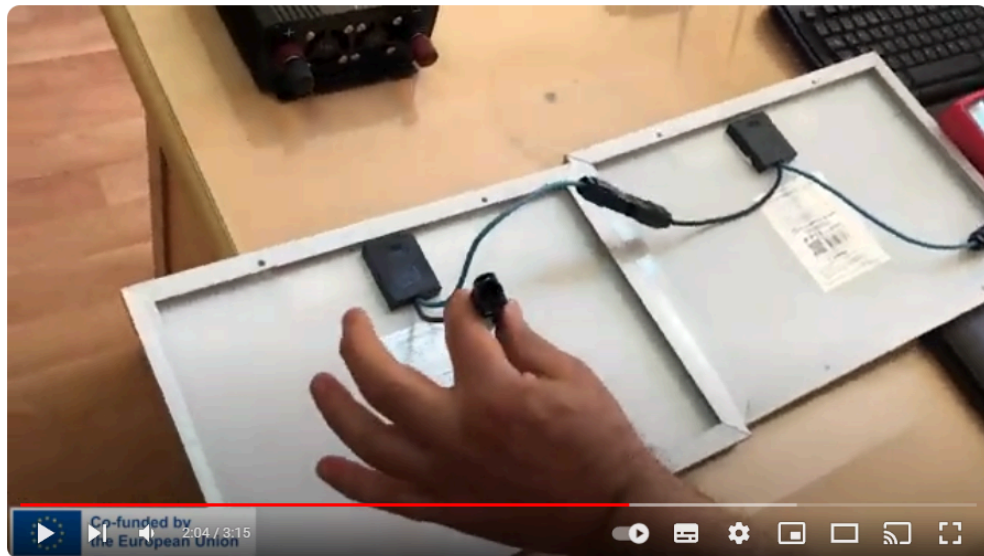

To play the video, click on the image or click the link below and open it with your browser:

<https://www.youtube.com/watch?v=kyQfsY-FLV4>

Serial connection of panels

As seen in the circuit in the figure, the connection made by joining the (+) end of one panel to the (-) end of the other panel with EMFs ϵ_1 , ϵ_2 , ϵ_3 and internal resistances r_1 , r_2 , r_3 is called series connection (Figure 2.4).

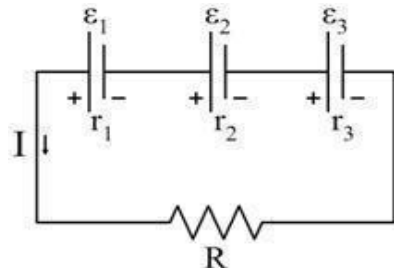

Figure 2.4: Serial connection

Formulas for series connected solar panels:

The potential difference is equal to the sum of the potential differences of the panels.

$$\varepsilon = \varepsilon_1 + \varepsilon_2 + \varepsilon_3$$

The value of the current passing through all panels is the same.

$$I = \frac{\varepsilon_1 + \varepsilon_2 + \varepsilon_3}{R + r_1 + r_2 + r_3} \qquad I = \frac{\sum \varepsilon}{\sum R}$$

The sum of the energies given by the panels in the circuit in time t is equal to the energy given by the equivalent module replacing these panels..

Example 1.1: 4 solar panels, each 10 volts, are connected in series. Find the total voltage that the solar array can deliver..

$$\varepsilon = \varepsilon_1 + \varepsilon_2 + \varepsilon_3 = 10 + 10 + 10 = 30 \text{ Volt}$$

Example 1.2: The internal resistance of four solar panels connected to each other in series is 0.1Ω . Find the total internal resistance.

$$r_{iT} = r_1 + r_2 + r_3 = 0.1 + 0.1 + 0.1 + 0.1 = 0.4 \Omega.$$

Example 1.3: The total internal resistance of three 8-volt panels connected in series is 0.9Ω . If the lamp connected to the ends of three panels connected in series draws 3 Amperes of current, how many volts is the voltage falling on the lamp ends?

Loss voltage (U_r) due to internal resistances on three panels:

$$U_r = R_r T \times I$$

$$U_r = 0.9 \times 3 = 2.7 \text{ volts}$$

$$U_L = U_P - U_r = (3 \times 8) - 2.7 = 24 - 2.7 = 21.3 \text{ volts.}$$

Series Connection of Non-Equivalent Solar Panels.

Non-equivalent panels are panels with different voltage, current or power ratings. When connecting such panels in series, the current of the panel with the lowest current value determines the current of the entire series. That is, when connecting non-equivalent panels in series, the total current value will be the current of the panel with the lowest current value..

Toplam Voltaj: $\varepsilon = \varepsilon_1 + \varepsilon_2 + \varepsilon_3$

Total Current: $I_{toplamlam} = \min(I_1, I_2, I_3, \dots, I_n)$

Example 1.4: Among the series connected solar panels, the first panel is 12 Volt and 5 Ampere, the second panel is 18 Volt and 3 Ampere. Calculate the current voltage values of the circuit.

$$\varepsilon = \varepsilon_1 + \varepsilon_2$$

$$\varepsilon = 12 \text{ volts} + 18 \text{ volts} \quad \varepsilon = 30 \text{ volts}$$

$$I_{toplamlam} = \min(I_1, I_2, I_3, \dots, I_n)$$

$$I_{toplamlam} = \min(5A, 3A) = 3 \text{ Amper}$$

Result: There will be a 30 Volt, 3 Ampere source..

Parallel Connection Solar Panels

Shading one panel does not affect other panels. This type of connection keeps the voltage constant while increasing the total current. Parallel connection is generally preferred in projects that require low voltage and short-distance energy transmission. It is more suitable for situations where the failure of one panel will not affect other panels, but low voltage levels can lead to energy loss.

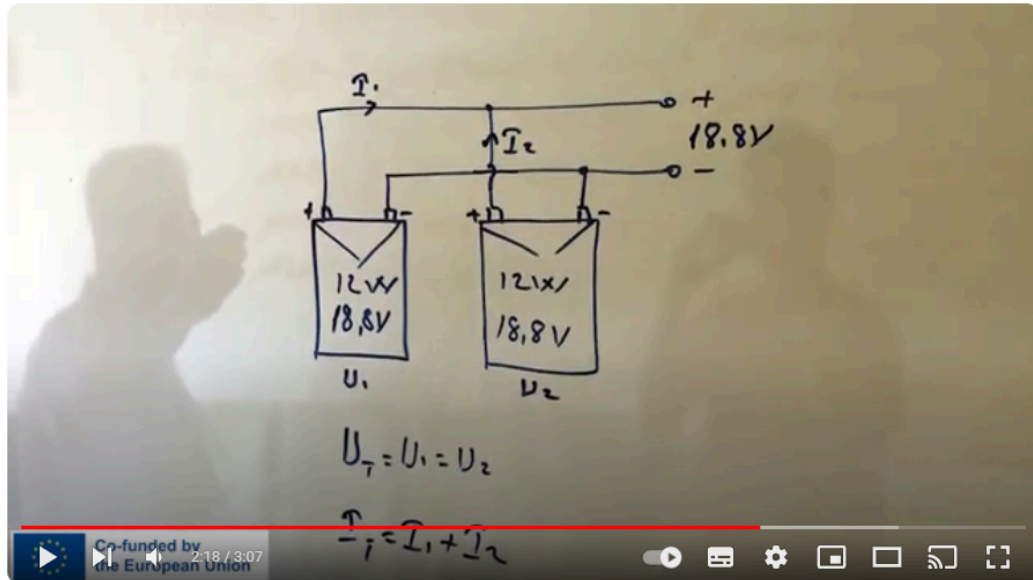

To play the video, click on the image or click the link below and open it with your browser.

<https://www.youtube.com/watch?v=VgLz6FvFbF8>

Parallel connection of panels

It is a system in which n panels with EMFs ϵ_1 and internal resistances r_1 are connected, the positive end of one panel is connected to the positive end of the other panel, and the negative end is connected to the negative end of the other panel (Figure 2.5).

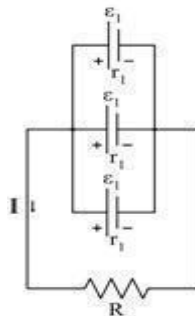

Figure 2.5: Parallel connection

In parallel connection, the EMFs of the panels must be equal. Otherwise, the current that must pass through resistor R may pass through intermediate circuits with small EMFs, causing undesirable situations.

The sum of the energies given by the panels in the circuit in time t is equal to the energy given by the equivalent module replacing these panels. In a parallel connected panel circuit, the equivalent

EMF is equal to the EMF of one of the panels..

$$\epsilon = \epsilon_1$$

If n identical panels with EMFs ϵ_1 and internal resistances r_1 are connected in parallel, the equivalent resistance is

$$r_{eq} = r_1/n.$$

Current intensity passing through the circuit,

$$I = \frac{\sum \epsilon}{\sum R} = \frac{\epsilon}{R + \frac{r_1}{n}}$$

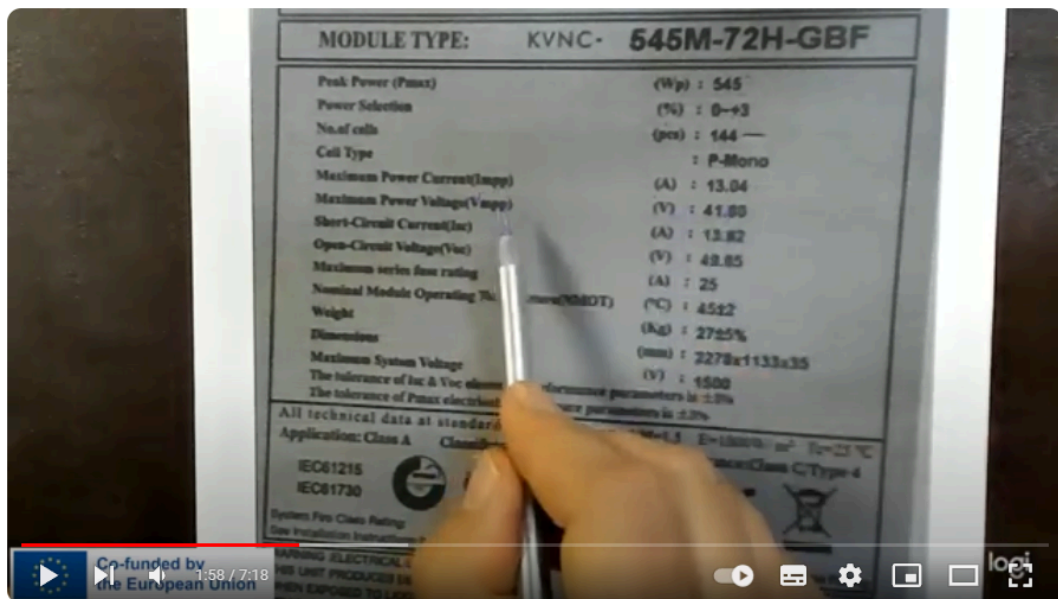

To play the video, click on the image or click the link below and open it with your browser:

<https://www.youtube.com/watch?v=Lq8QuMSKLLQ>

Parallel connection of non-equivalent solar panels

Non-equivalent panels are panels with different voltage, current or power ratings. When connecting such panels in parallel, the voltage of the panel with the lowest voltage value determines the voltage of the entire series.

$$\text{Toplam Akım: } I_{toplam} = I_1 + I_2 + I_3 + \dots + I_n$$

$$\text{Toplam Voltaj: } \epsilon_{toplam} = \min(\epsilon_1, \epsilon_1, \epsilon_1, \dots, \epsilon_n)$$

Example 1.5: Let's say you have 2 different solar panels. The first panel is 12 Volts and 5 Amps, the second panel is 18 Volts and 3 Amps. According to this:

$$I_{toplam} = I_1 + I_2$$

$$I_{total} = 5 + 3 = 8 \text{ Amper}$$

$$V_{total} = \min(12 \text{ Volt}, 18 \text{ Volt}) = 12 \text{ Volt}$$

Result: There will be a 12 Volt 8 Ampere source.

Mixed connection is a system in which serial and parallel connections are used together. This type of connection can increase the total voltage and current stably. Mixed connection is

generally preferred in projects that require both high voltage and high current. However, in this type of connection, failure or shadowing of one panel will not negatively affect the entire system. On average, mixed connections provide balanced energy efficiency but also have a more complex structure. In such circuits, the EMF and internal resistance of equivalent panels in parallel and series connected parts are calculated. Then the current intensity passing through the circuit is found.

$$\text{Toplam Voltaj: } \varepsilon_{toplam} = \varepsilon_{seri}$$

$$\text{Toplam Akım: } I_{toplam} = I_{seri} + I_{paralel}$$

NOTE: When solving mixed circuit connections, first serial connection calculations are made and then parallel connection calculations are made.

Example 1.6: Four 12 Volt 5 Ampere solar panels are first connected in series in pairs, and these two series connected panel groups are connected in parallel to each other. Accordingly, find the current and voltage values of the circuit.

Step 1: Serial Connection:

First, let's look at the panel groups connected in series. Since the panels are equivalent, the same formulas and procedures are valid for the first group and the second group..

$$\varepsilon_{toplam} = \varepsilon_1 + \varepsilon_2$$

$$\varepsilon_{toplam} = 12 + 12 = 24 \text{ Volt}$$

$$I_{toplam} = I_1 = I_2$$

$$I_{toplam} = 5 \text{ Amper}$$

In this case, each series group would be 24 Volts and 5 Amps. Step 2: Parallel Connection:

Now we have two 24 Volt 5 Ampere solar panels and if these two are connected in parallel to each other,

$$\varepsilon_{toplam} = \varepsilon_1 = \varepsilon_2$$

$$V_{toplam} = 24 = 24 \text{ Volt}$$

$$I_{toplam} = I_1 + I_2$$

$$I_{toplam} = 5 + 5 = 10A$$

Conclusion

With this mixed connection, we obtain an energy source of 24 Volts and 10 Amperes.

2.6. Efficiency in Solar Panels

Efficiency, a parameter that determines the performance of solar panels, is the ratio of the energy received from solar panels to the energy coming from the sun. With today's technology, theoretical efficiency is around 33%.

Considering the energy coming out of the sun as 100%, the average amount of sunlight entering the Earth's atmosphere is approximately 51% of the total energy entering the atmosphere. The other parts of this incoming energy are 30% reflected in space and 19% absorbed by the atmosphere and clouds. Up to 33% of the energy reaching the surface can be converted into electrical energy by the silicon solar cell. This upper limit is called the Shockley and Quiser (SQ) limit.

To determine the efficiency of the solar panel, it is necessary to compare the power provided by the sun to the panel and the electricity produced. If solar panels could convert all of the sunlight falling on them into electrical energy, they would be 100% efficient. However, it is not possible to reach such an efficiency level in today's technology and due to the laws of physics. The efficiency of the solar panel created from solar cells will be lower due to the gaps between the cells, the frame and reflective conductors. Multilayer solar cells can exceed this limit, but their production is much more laborious and costly..

Near the equator and at noon, over 1 kW (1,000 W) of solar radiation reaches every square meter of the earth's surface. This will be at a lower level farther from the equator, in different seasons and under different weather conditions. However, when testing solar panels, the standard value of 1 kW per square meter is used.

If a solar panel with a surface area of 1 m² could receive 1 kW of sunlight and convert it into 1 kW of electrical energy, the efficiency of the panel would be 100%. If a solar panel with a surface area of 1 m² produces 230 W power, its efficiency is 230 W / 1,000 W x 100 = 23%.

The approximate efficiency of a solar panel can be calculated with the following formula.

$$\text{Efficiency (\%)}\eta = 100 \times \text{Maximum panel power (kW)} / \text{Panel area (m}^2\text{)}$$

The highest amount of electrical power that the solar panel can provide is the maximum power of the panel.

$$\eta = \text{Maximum Panel power} / \text{Panel area} \times 100 \Rightarrow \text{panel efficiency calculation}$$

Example: The efficiency of a solar panel with a power of 550 W and dimensions of 197 x 130 cm is calculated as follows.

Solution:

$$\text{We can calculate its efficiency as } \eta = 100 \times 0.55 / 1.97 \times 1.3 = 36.2\%$$

2.7. Panel Layout

In the modules for preparing the solar panel system in buildings and open areas, the stand on which the panel would be placed was positioned according to the direction and angle setting. After all this, the solar panels selected for the project should be carefully carried to the stand to be assembled and placed on the stand. In order to prevent solar panels from being affected or damaged by adverse weather conditions, they should be mounted on the stand using appropriate equipment (Picture 2.11).

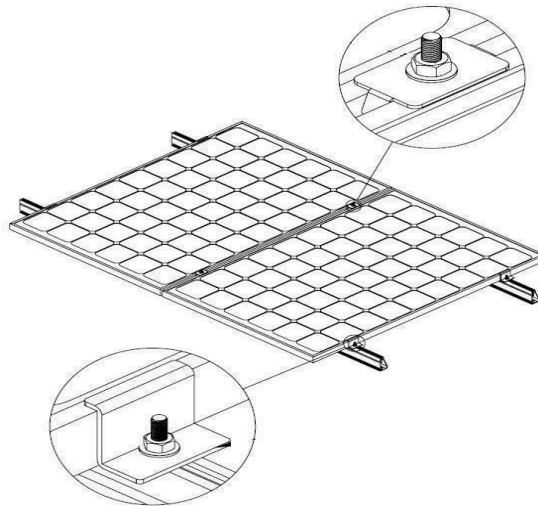

Picture 2.11: Solar panels installed with appropriate equipment

Installing solar panels requires a certain level of skill and knowledge. These jobs should only be carried out by qualified and specially trained personnel. Care should be taken when handling or wiring panels exposed to sunlight. Panels should not be fixed from a single point. In windy weather, panels may come loose from their connection points.

It is necessary to comply with the following instructions for the placement (installation) of solar panels.:

- Do not install the panels next to equipment or in areas where flammable gases will escape or collect.
- Do not use mirrors or equipment that artificially collects sunlight.
- Keep children away from the system when installing and moving mechanical and electrical components.
- Do not carry metal rings, watch bands, ear, lip or nose earrings or other metal devices when installing and troubleshooting photovoltaic systems.
- Do not make holes on the glass surface of the panel. Doing so will destroy the panel and void the warranty.
- Do not drill additional mounting holes in the panel frame. Doing so will void the panel's warranty.
- Do not lift the panel up by holding the panel's junction box or electrical plates.
- Do not apply paint or glue to the panel.
- Do not stand on the panel or step on the panel. There is a risk of glass breaking, serious injury or death.
- Do not drop the panel or allow objects to fall on the panel.

- Do not place any heavy objects on the panels.
- Improper transportation and installation may damage the panel glass or the solar cells inside the panel

3.PANEL WIRING

3.1. Panel Cable Selection

Efficiency is very important in solar electricity generation applications, solar cells, solar panels and solar panel systems. In order to keep energy loss to a minimum level, utmost attention should be paid to the conductor cross-section size of the electrical cable used. Otherwise, serious efficiency loss will occur. Improper designs may even cause overheating and fire hazards. In photovoltaic system installation, calculating the system and selecting the required products is not easy. The importance of connection products, which are generally neglected and should not be neglected, is extremely high. When you examine the cost of a system, the value of fittings is limited to ~5% on average. However, when you make the wrong choice in connection products, you may face the risk of fire, incur high losses, and more importantly, human life may be at stake.

Solar type cables produced specifically for photovoltaic applications are specially produced with superior quality raw materials (Picture 3.1). In photovoltaic applications where energy transmission is of particular importance, the use of normal cables reduces the system efficiency and does not have the required long life. Especially when it comes to transporting energy over long distances (20 m and above), photovoltaic cables must be used. These cables are an important part of photovoltaic systems. The connection of photovoltaic systems inside or outside buildings and devices is specially designed for regions with high mechanical wear and harsh weather conditions. As the length of the cables used in solar energy systems increases, as the distances get longer and/or the current passing through the cable increases, there is a voltage drop on the cable that should be conductive, that is, resistance occurs in some way. At this point, the importance of calculating the appropriate cable cross-section and selecting cables with suitable/sufficient features becomes evident.



Picture 3.1: Solar cable

Due to the superior properties explained above, it is inevitable to use solar (photovoltaic) cables specially prepared with superior quality raw materials for these systems in photovoltaic systems.

Photovoltaic cables contain tinned copper conductor wire conforming to VDE 0295 / IEC60228 class 5. The inner part of the cable consists of a special copolymer combined electronically with rays and a second polyolefin copolymer layer surrounding it. The nominal cable cross-section of solar cables must be approved by TÜV. It should have a dense cable diameter and not take up much space. It must definitely be long-lasting and durable.

In general, the features that photovoltaic cables should have can be listed as follows::

- There must be special electron beam textured insulation and sheath.
- It is resistant to extreme heat and cold.
- It is oil resistant.
- Resistant to friction.
- It is resistant to ozone.
- Resistant to ultraviolet rays.
- It is resistant to bad weather conditions.
- It has better protection against fire, does not produce much smoke and does not burn.
- It does not contain halogen.
- It is very flexible.
- Insulation is easy to open.
- It takes up little space.
- It has high mechanical strength.
- Leakage losses are minimal.
- It is long lasting.

The solar system can be divided into two parts: It consists of Solar Panel System-Battery and Battery-Consumer parts. The solar panel system-battery section is the DC (direct current) section and is generally installed as 12, 24 or 48 V DC. In the solar panel system-battery section, the electric current produced by the solar panels is stored in the batteries via the charge controller. If my system power is taken as 1000 W and the system is installed as 12 V DC;

$$P = I \cdot V$$

$$I = P / V = 1000W / 17V = \sim 58 \text{ A}$$

Here the current; It is calculated by dividing the panel power by the voltage generated in the panel and not corrected in the charge controller (17 V). The main reason for having a charge controller in the system is to regulate this output voltage and ensure that the battery is charged at the nominal value (12 V). The connection cable selected for this system must have a current carrying capacity of at least 58 A. If a 5 m long cable needs to be laid, the cable cross-section must be calculated as follows..

Formula to be used to calculate cable cross-section:

$$S = ((0,0175) \cdot 2 \cdot L \cdot P) / \rho \cdot U^2 = ((0,0175) \cdot 2 \cdot 5 \cdot 1000) / (0,03 \cdot 17^2) = 175 / 8,67 = 20,18 \text{ mm}^2$$

However, 35 mm² cable cross-section, which is the upper cable cross-section closest to this value, is used in the cable table (Table 2.1).

S = Conductor cross section (mm²)

fk[%] = Conductor loss for copper(3%)(0.03)

0.0175 = Specific resistance for copper(Ohm × mm² / m)

L = Cable length(m)

P = Power to be received by the cable (W)

U = Solar panel system voltage (V)

The cable cross-section to be used can be found by making calculations according to the given formula. The data used in the formula was calculated in a computer environment and a practical table was created. In Table 3.1, the required and standard cable cross-sections for various amperage and cable lengths for 12 volts are presented. For the solar panel system designed to produce 1 kW of power per hour, which should have a current carrying capacity of 58 A per hour, it is deemed appropriate to use cables with a cross-section of 35 mm² for distances longer than 4 meters.

Kablo Uzunluğu [m]	0-1	1-2	2-3	3-4	4-5	5-6	6-7	7-9
Amper [A]	Kablo Kesiti [mm ²]							
0-20	2,5	6	6	6	10	10	10	10
21-36	6	6	10	10	20	20	20	35
37-50	6	6	10	10	20	20	20	35
51-65	10	10	20	35	35	35	35	35
66-85	20	20	35	35	35	35	35	35
86-105	20	20	35	35	35	35	35	35
106-125	35	35	35	35	35	35	35	35
125-150	35	35	35	35	35	35	35	35
151-200	35	35	50	50	50	50	50	50

Table 3.1: Cable selection in solar panel systems (for 12volt)

3.2. Panel Arm Connections

To produce electricity at large powers, solar panels are connected together to form solar PV arrays. Multiple solar panels are connected to each other in parallel or series to increase power output. When connecting solar panels to each other, solar cables that comply with the solar panel cable selection criteria in the previous topic should be preferred.

Solar cables and connectors should be used when connecting solar panels (Picture 3.2).



TYCO ELECTRONICS		
Ürün	Solar kablo	Konnektör
Kesit	2.5; 4; 6 mm ²	2.5; 4; 6 mm ²
Minimum sıcaklık	-400C	-400C
Maksimum sıcaklık	1250C	1100C
Mevcut renkler	Siyah, mavi, kırmızı	Standard
Bağlantı şekilleri	-	Dişi, Erkek, T branch
Akım taşıma kapasitesi	2.5 mm ² - 41 A 4 mm ² - 55 A 6 mm ² - 70 A	25 Ampere kadar
Onay	IEC 60228 Class5 TÜV ve UL	TÜV ve UL

Picture 3.2: Solar cable and connector features

When connecting solar panels to each other, female or male connectors are connected to the junction boxes on the panels (Picture 3.3, Figure 3.1). When solar panels are connected in parallel with each other, parallel connection connectors are used (Picture 3.4).



Picture 3.3: Female and male solar cable connector



Figure 3.4: Connector for parallel connection to panels

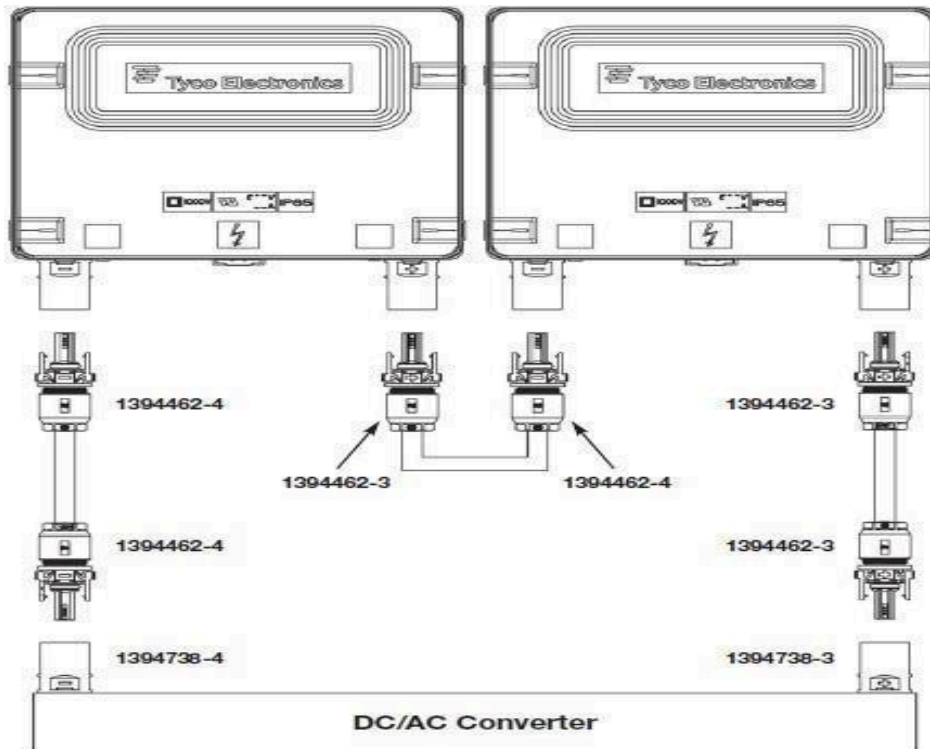

Figure 3.1: Junction box and connectors on the panels

Application examples of serial and parallel wiring of solar panels with connectors are shown below (Figure 3.2).

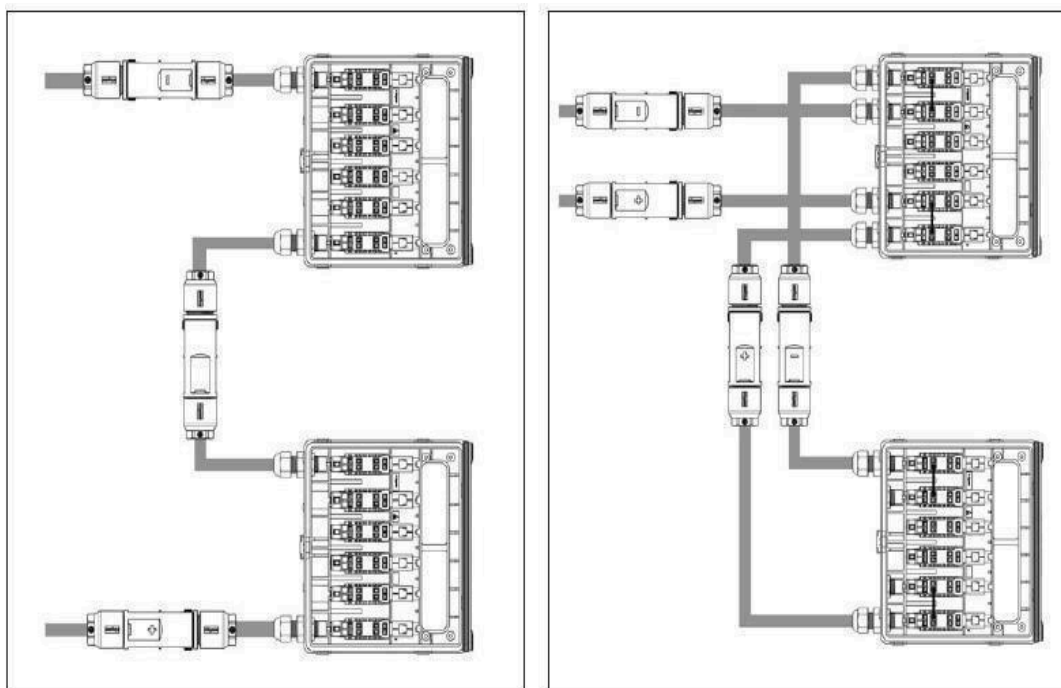

Figure 3.2: Serial and parallel cabling examples

In the example below, 4 solar panels are connected to each other in series with the help of male and female connectors (Figure 3.3).).

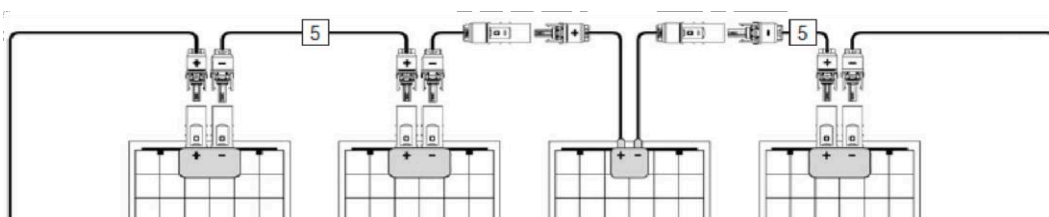
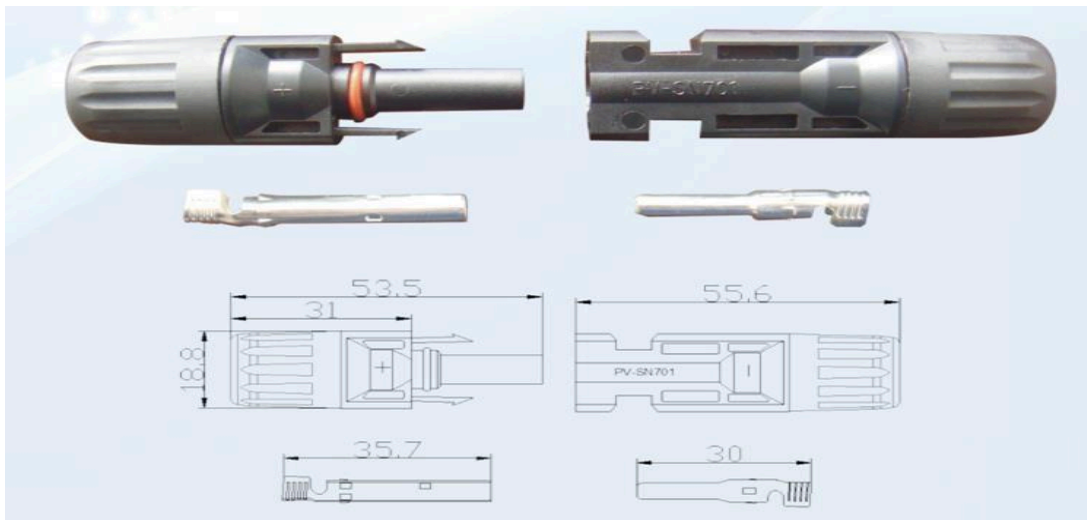

Figure 3.3: Cabling example of 4 solar panels connected in series with cable connector

3.3. Cable Connector Connection

Solar energy systems constitute one of the most efficient energy sources today. It is a system frequently preferred by those who want to save electrical energy, meet their electricity needs in regions where electricity is not available, or use an alternative energy source to electrical energy. The demand is increasing day by day and when it is done by truly professional people, it works according to its purpose. This system consists of several main parts. Each part is of great importance for the proper functioning of the system. The solar connector is one of these parts.

Solar connector, in other words the connector part in Turkish, is a mechanism that ensures that solar cables are connected to each other properly and plays an important role in the proper functioning of the system. The required current is transferred from cable to cable with this mechanism. It consists of two parts, male and female (Picture 3.4).



Picture 3.4: Male and female solar cable connector

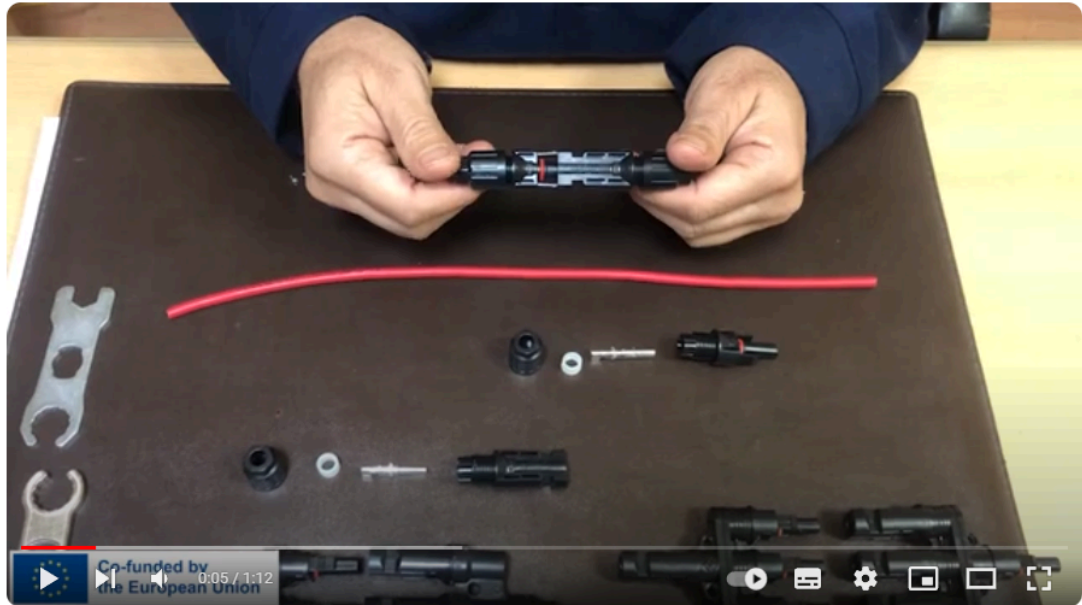

To play the video, click on the image or click the link below and open it with your browser.

<https://www.youtube.com/watch?v=Tvt-Ch-bpe8>

In addition to safety for the user, solar connectors provide serious convenience in connecting the system to each other. Moreover, if we consider the cost of system failures caused by its deficiency, we can say that it is much cheaper. In short, the solar connector prevents loss of time during the installation phase of the system and provides safety for the user. (Figure 3.5). It also reduces cost. In this way, the system can be connected in parallel or serially (Figure 3.7).

Connector is one of the vital parts of a system. That's why standards and certifications have been determined. When you buy a solar connector, care should be taken to ensure that it complies with these standards and certificates. Care should be taken to ensure that it is the same type and brand when you use it..



Figure 3.5: Solar connector connection components

The equipment used to incorporate the connector into the system must be suitable for its purpose. Instead of tools such as utility knives or pliers, special equipment used for squeezing and stripping should be preferred, as recommended by the manufacturer (Picture 3.6).



Picture 3.6: Solar cable stripping and crimping pliers set









Picture 3.7: Solar connector connection



To play the video, click on the image or click the link below and open it with your browser.

<https://www.youtube.com/watch?v=rJTt1zszYOI>

3.4. Solar Connector Types

	MC4 PV Konnektör - Erkek / Dişi
	MC3 Paralel Bağlantı - Dişi
	MC3 Paralel Bağlantı - Erkek
	MC4 Paralel Bağlantı - Dişi
	MC4 Paralel Bağlantı - Erkek
	MC3 PV Uzatma Kablolü Konnektör Erkek / Dişi
	MC4 PV Uzatma Kablolü Konnektör Erkek / Dişi

REFERENCES

- Eshia Enerji SL. (2024). *Training notes*. Eshia Enerji SL. <https://www.eshia.es/>
- N2 Anima GmbH. (2024). *Training notes*. N2 Anima GmbH. <https://n2anima.com/>
- European Commission. (2024). *Photovoltaic Geographic Information System*. https://re.jrc.ec.europa.eu/pvg_tools/en/tools.html
- Kıvanç Solar Panel Production Facility. (2024).
- Keçel, S. (2007). *Development of a model for meeting household electricity needs with solar panels in different regions of Turkey* (Master's thesis, Gazi University, Institute of Science).
- Ewing, R. A. (2003). *Power with Nature: Solar and Wind Energy Demystified* (1st ed.). Pixyjack Press.
- Foley, G. (2005). Photovoltaic energy: Applications in rural areas of the developing world. In A. Kandemir (Ed.), *Turkey Development Bank A.Ş.* (pp. 10-42). Ankara.
- Gilbert, M. M. (2004). *Renewable and Efficient Electric Power Systems*. John Wiley & Sons.
- Güven, S. Y. (2006). An example application of solar cell-assisted environmental lighting and irrigation systems. *Engineer and Machine*, 548, 46-48.
- Quaschnig, V. (2005). *Understanding Renewable Energy Systems*.
- Köroğlu, T., Teke, A., Bayındır, K. Ç., & Tümay, M. (n.d.). *Design of solar panel systems*. Çukurova University, Department of Electrical and Electronics Engineering.
- Solargis sro. (2024). *Solargis sro*. <https://solargis.com/>
- Electrical Engineers Chamber Mersin Branch. (2019). *GES Brochure*.
- Ceylan, İ., & Gürel, A. E. (2022). *Solar Energy Systems and Design*.
- Entegro Energy Systems. (2024). *Entegro Energy Systems*. <https://entegro.com.tr/>
- Eşme, U. (2023). *Lecture notes*. Tarsus University, Faculty of Engineering.
- Ministry of National Education (MEB). (2022). *Renewable Energy Systems MEGEP modules*.
- Solarvizyon. (2023). *Solarvizyon*. <https://solarvizyon.org/>
- 123RF. (2024). *123RF*. <https://www.123rf.com>
- Durak, M., & Özer, S. (2012). *Solar Energy: Theory and Practice*.
- Phonosolar. (2024). *Phonosolar*. <http://www.phonosolar.com/>
- Smart Solar Technologies. (2024). *Smart Solar Technologies*. <https://www.smartsolar.com.tr/>
- Öztürk, A., & Dursun, M. (2011). *Design of 2, 10, and 20 KVA photovoltaic systems*. Düzce University.
- Göktekin Energy. (2023). *Operation and maintenance checklist*.